

Per ordinare ricambi segnalare codice e quantità - For spare parts orders please mention code and quantity - Pour commander les pieces rechanges, indiquer le code et la quantité

29/10/10

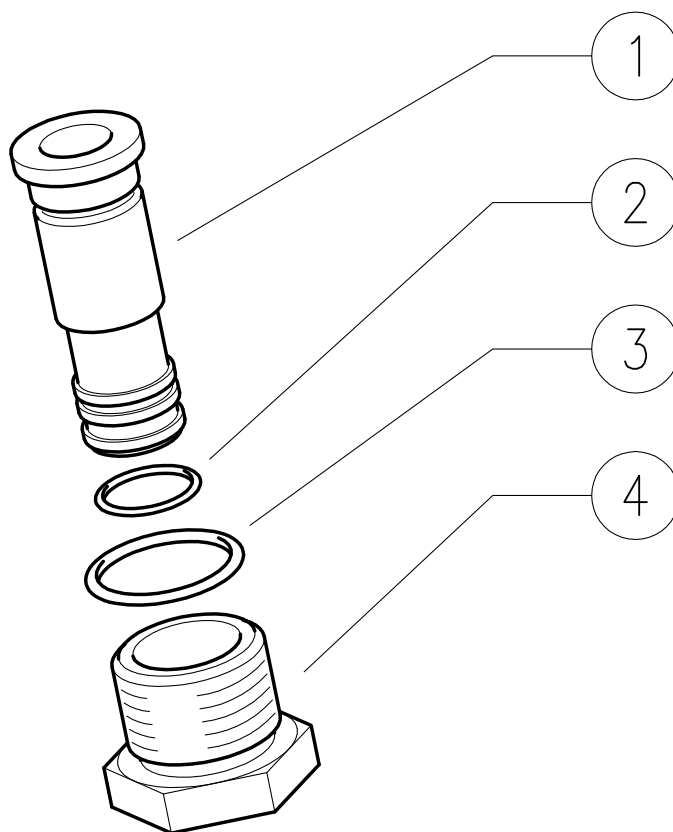

POS	CODICE	DENOMINAZIONE	Q	PACK
1	30.6431.31	Perno portagomma 13mm ott.	1	1
2	10.3060.00	An.OR 1,78x12,42 mm	1	10
3	10.3092.90	An.OR 2x19 mm	1	10
4	30.6432.31	Racc. SW G1/2M ott.	1	3